

Arkitektforum for helsebygg
Nye Aker
29.04.21

Området

Aker helsearena

Oslo
storbylegevakt

Fredede bygg,
krigsbeltet

Bygningene rives
(de fleste)

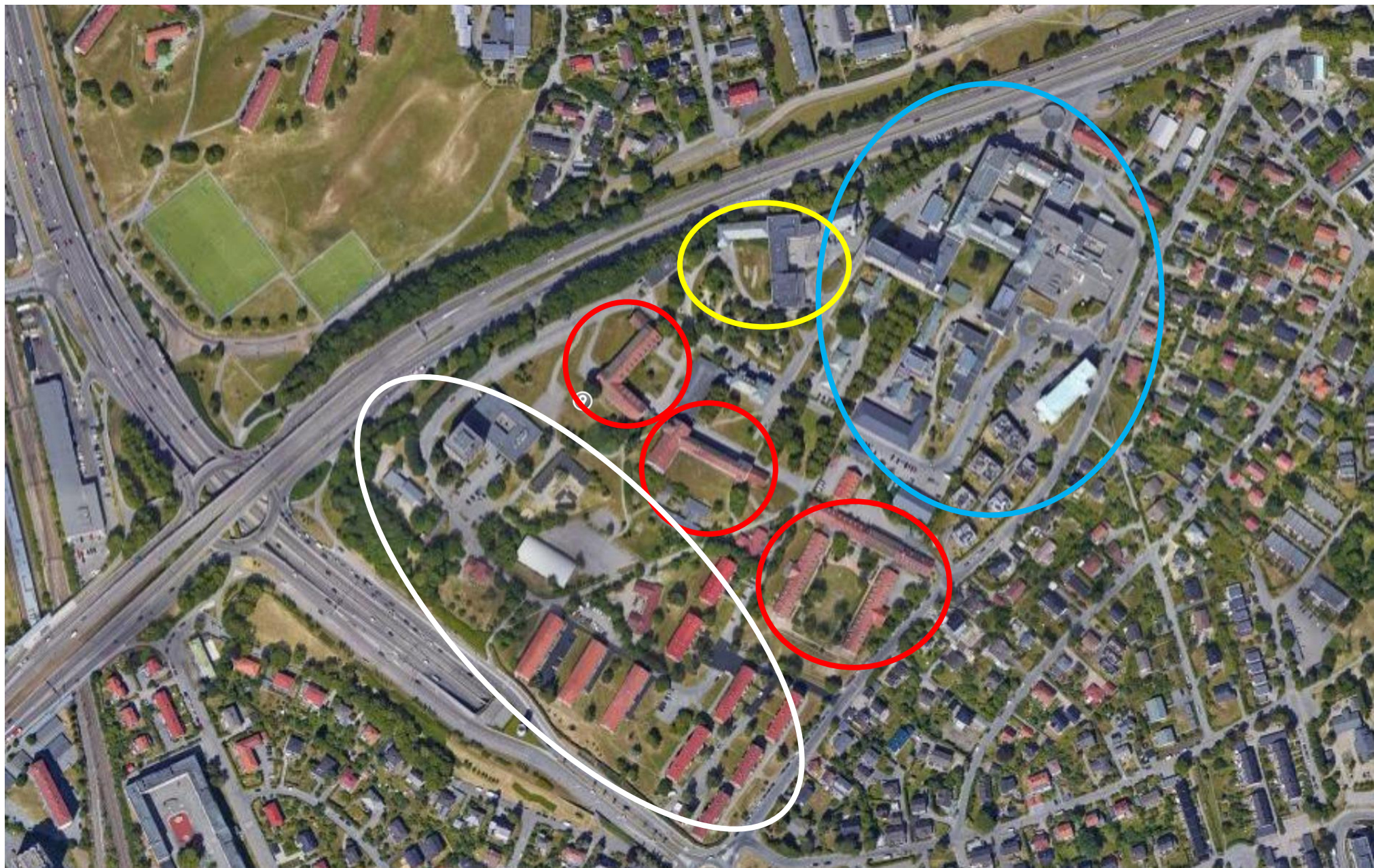

Nye Aker

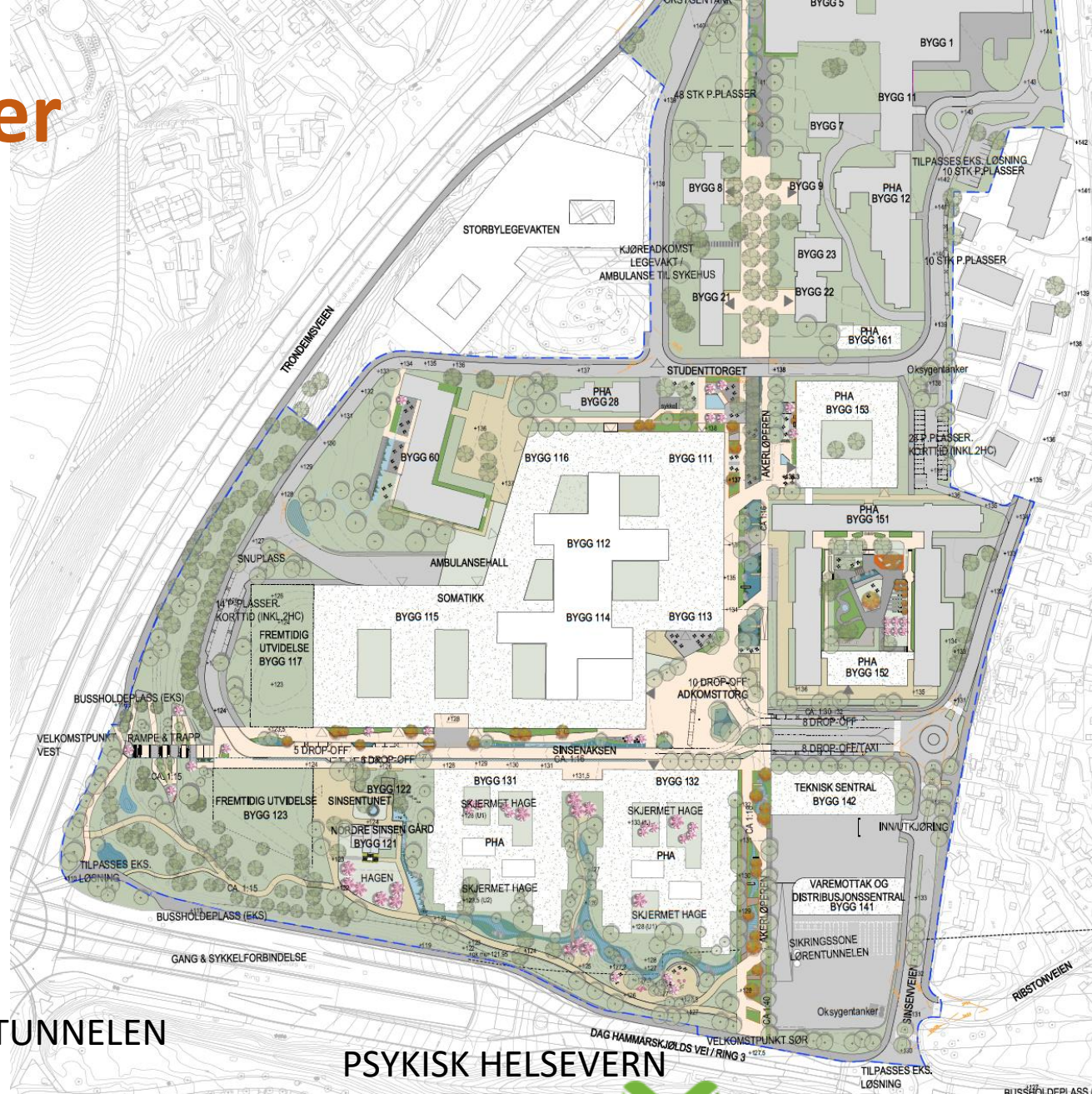

AKER HELSEARENA

SOMATIKK

PSYKISK HELSEVERN

SINSENKRYSSET

VARELEVERING OG
TEKNISK SENTRAL

RING 3 - LØRENTUNNELEN

PSYKISK HELSEVERN

Trafikk og kommunikasjon

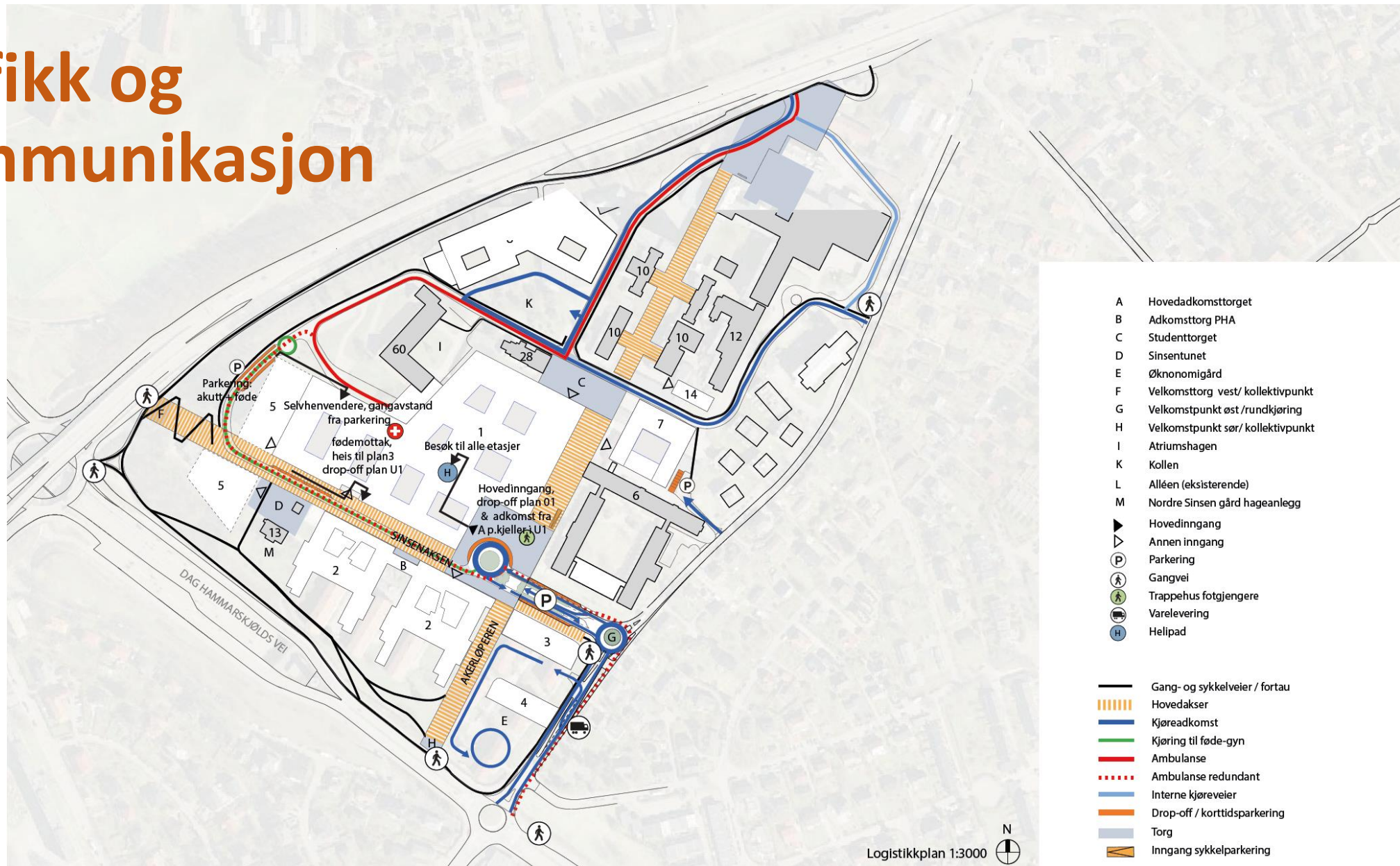

- A Hovedadkomsttorget
- B Adkomsttorg PHA
- C Studenttorget
- D Sinsentunet
- E Øknonomigård
- F Velkomstorg vest/ kollektivpunkt
- G Velkomstpunkt øst/rundkjøring
- H Velkomstpunkt sør/ kollektivpunkt
- I Atriumshagen
- K Kollen
- L Alléen (eksisterende)
- M Nordre Sinsen gård hageanlegg
- ▶ Hovedinngang
- ▷ Annen inngang
- P Parkering
- ⤴ Gangvei
- ⤴ Trappehus fotgjengere
- 🚚 Varelevering
- 🚁 Helipad

- Gang- og sykkelveier / fortau
- ▨ Hovedakser
- Kjøreadkomst
- Kjøring til føde-gyn
- Ambulanse
- ⋯ Ambulanse redundant
- Interne kjøreveier
- Drop-off / korttidsparkering
- ▨ Torg
- ▨ Inngang sykkelparkering

Nye Aker sett fra sørøst



TEAM  AKER

Base og høyhus

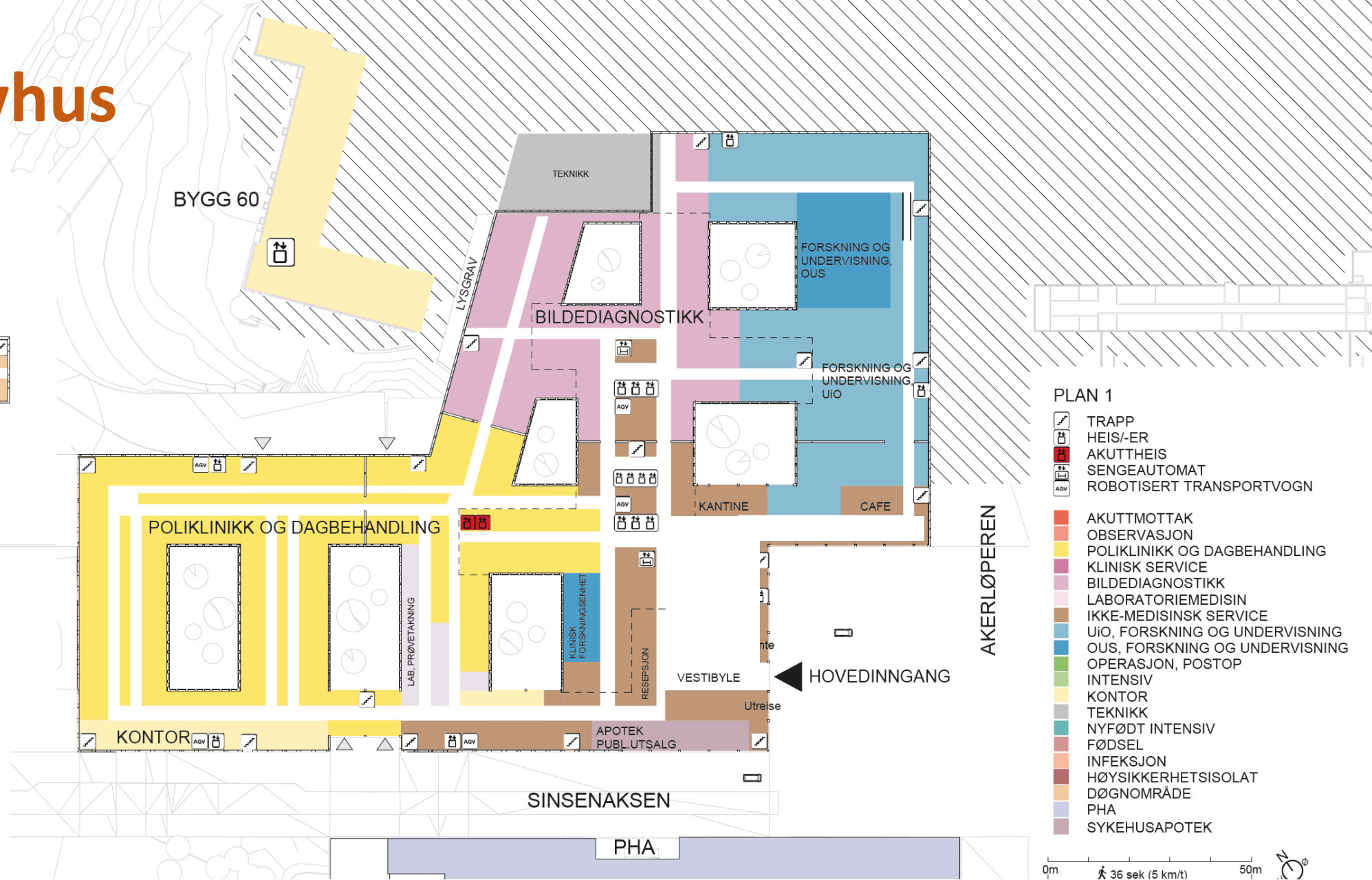
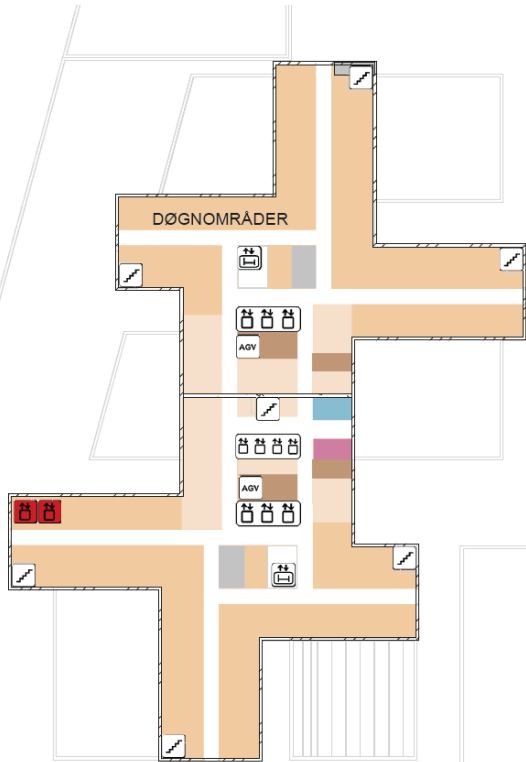

- PLAN 1**
- TRAPP
 - HEIS/-ER
 - AKUTT/HEIS
 - SENGEAUTOMAT
 - ROBOTISERT TRANSPORTVOGN
 - AKUTTMOTTAK
 - OBSERVASJON
 - POLIKLINIKK OG DAGBEHANDLING
 - KLINISK SERVICE
 - BILDEDIAGNOSTIKK
 - LABORATORIEMEDISIN
 - IKKE-MEDISINSK SERVICE
 - UIO, FORSKNING OG UNDERVISNING
 - OUS, FORSKNING OG UNDERVISNING
 - OPERASJON, POSTOP
 - INTENSIV
 - KONTOR
 - TEKNIKK
 - NYFØDT INTENSIV
 - FØDSEL
 - INFEKSJON
 - HØYSIKKERHETSISOLAT
 - DØGNOMRÅDE
 - PHA
 - SYKEHUSAPOTEK

0m 36 sek (5 km/t) 50m

Veifinning inne som ute



Teknisk forsyning

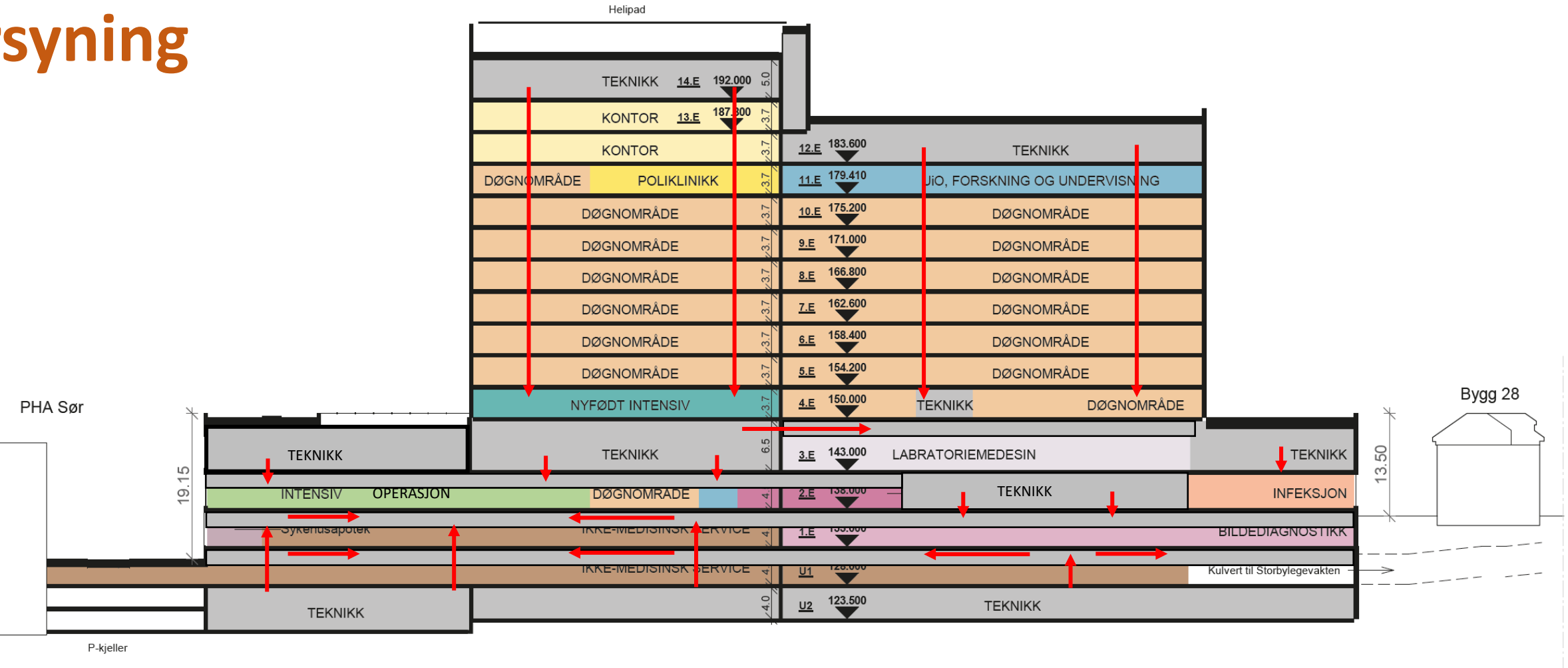

Logistikk og organisering

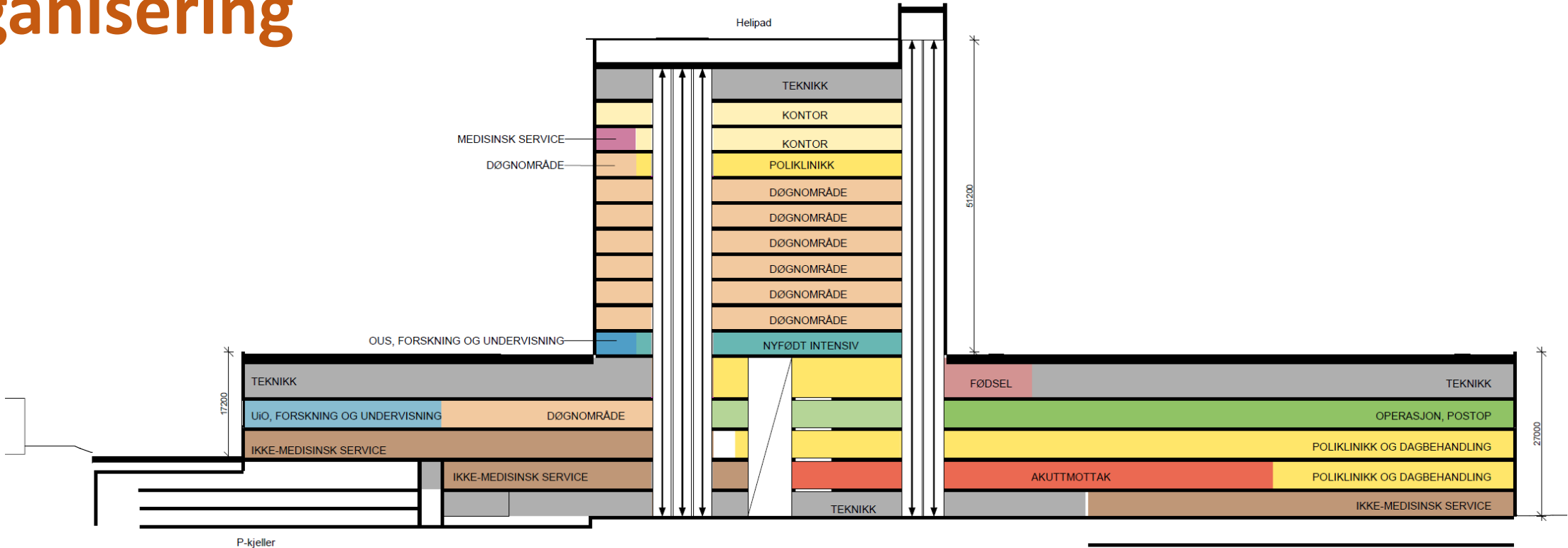

Organisering psykisk helsevern

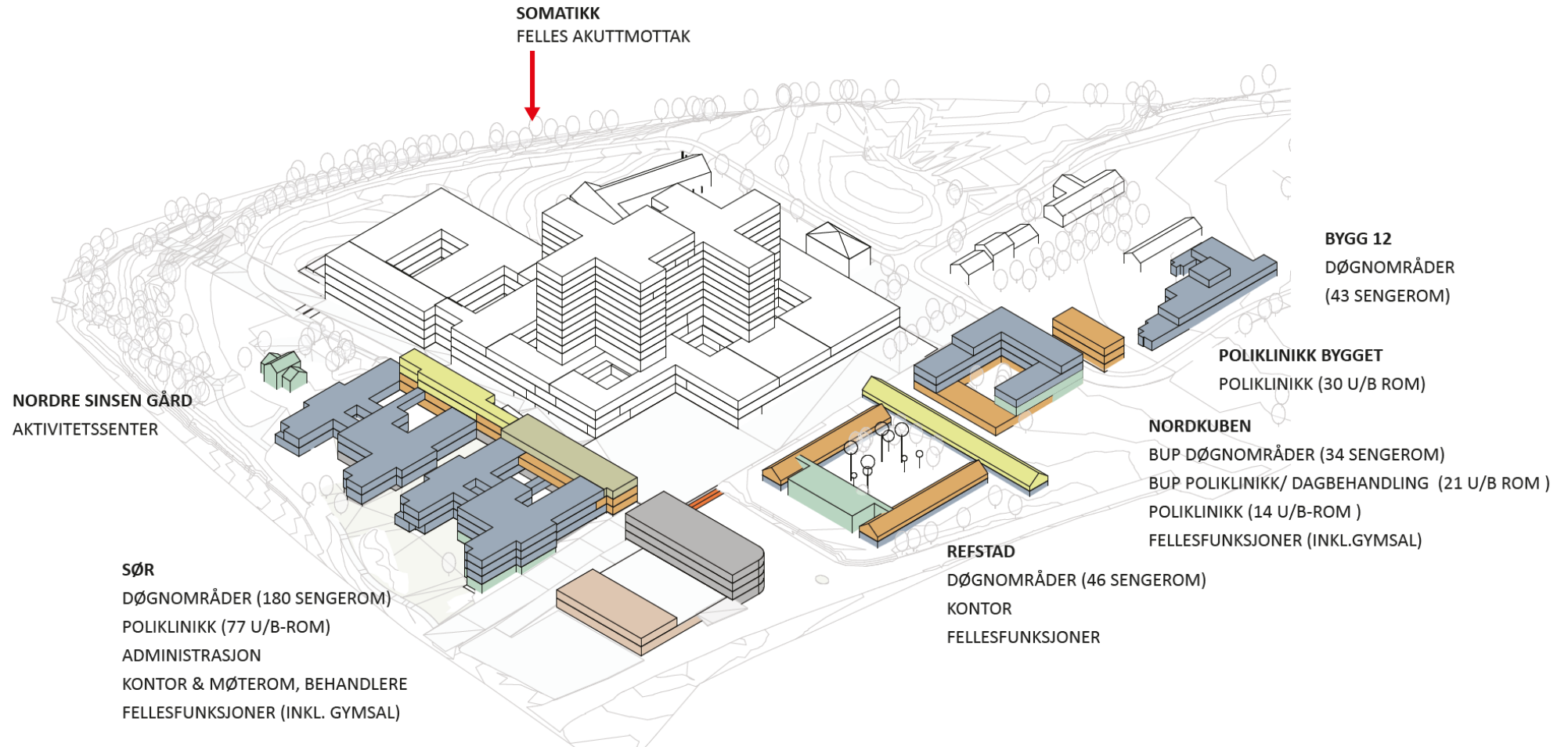

Døgnområde psykisk helsevern

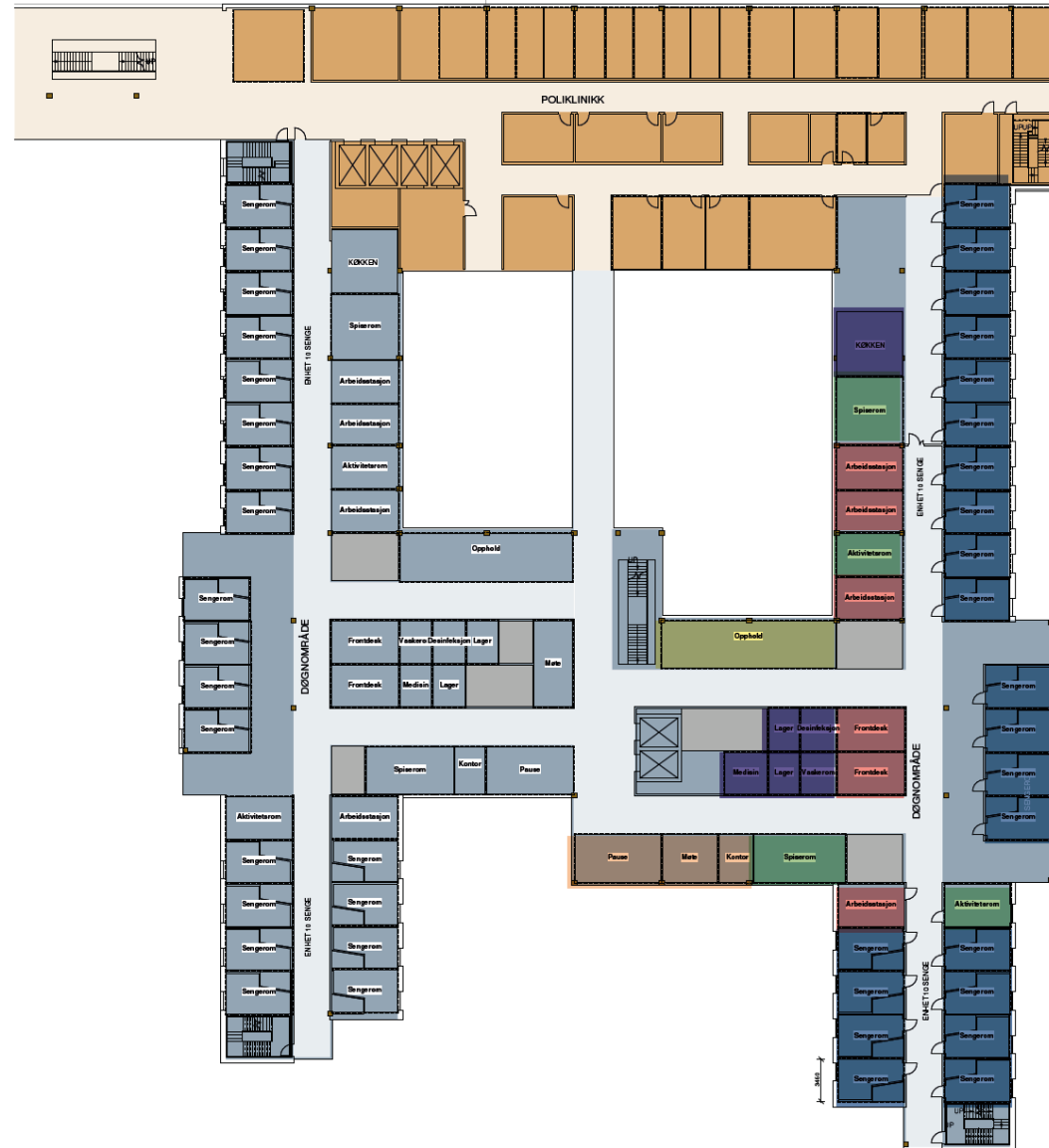

Prisippsnitt psykisk helsevern

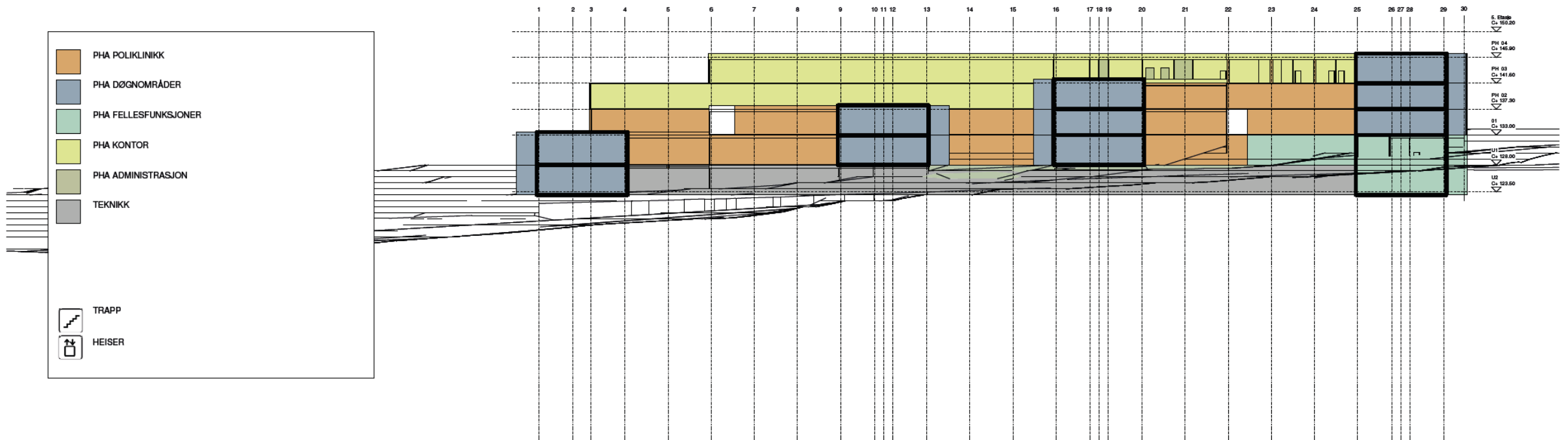

Konstruksjon i massivtre

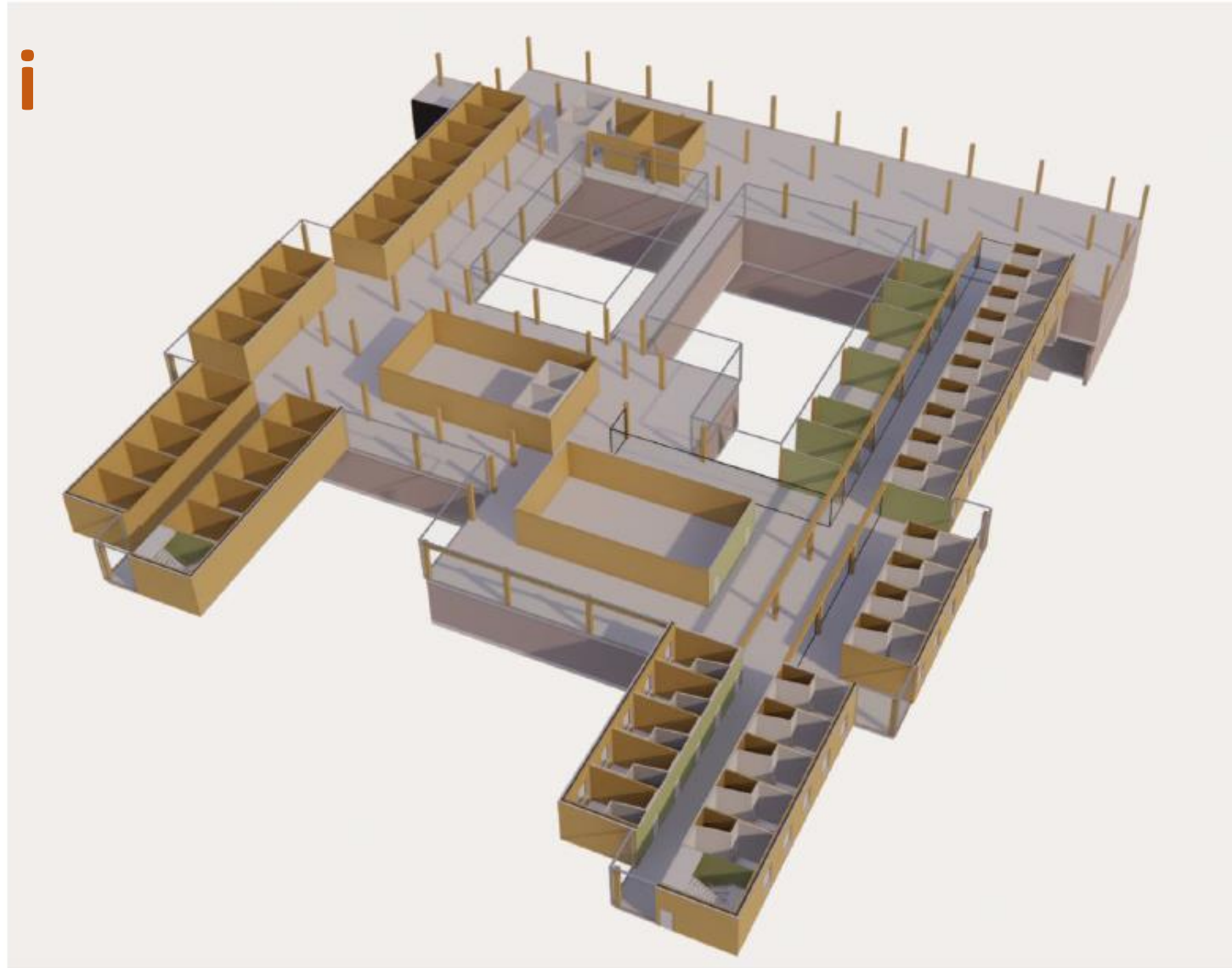

Studier bygg – uterom - gater



Studier inne - ute



Studier dagslys- fasader

15.04.2021
 NYE AKER SYKEHUS – PROSESSLOGG - UKE 15
 FASADER OG VOLUM

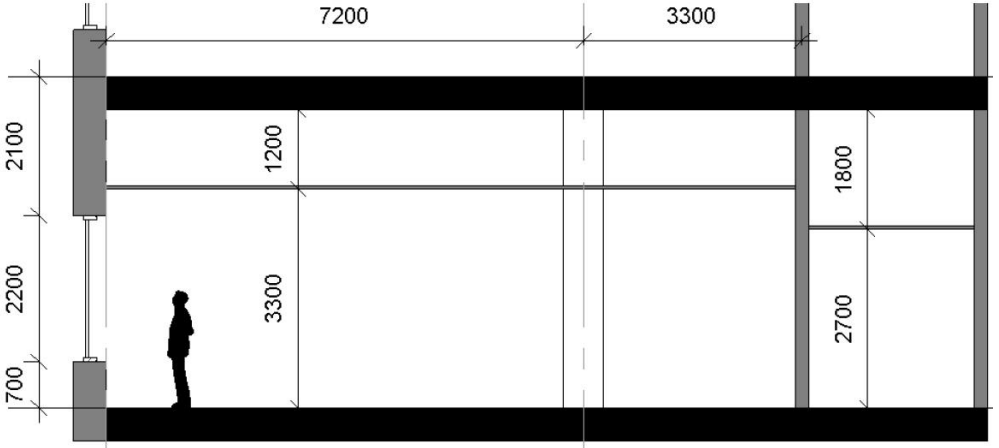
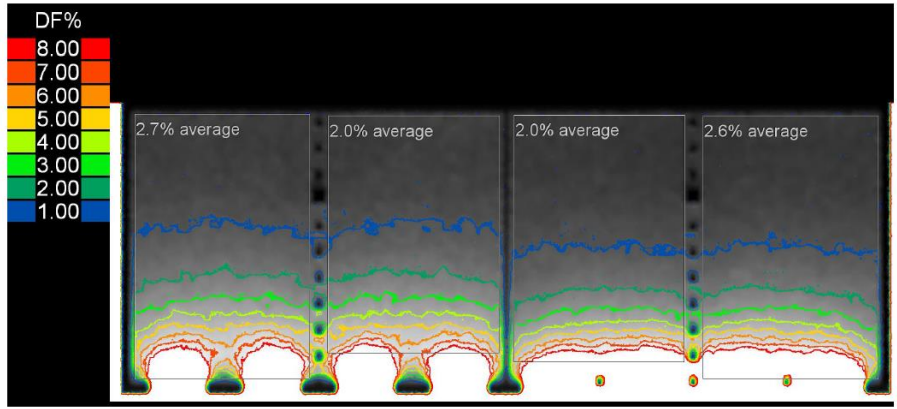
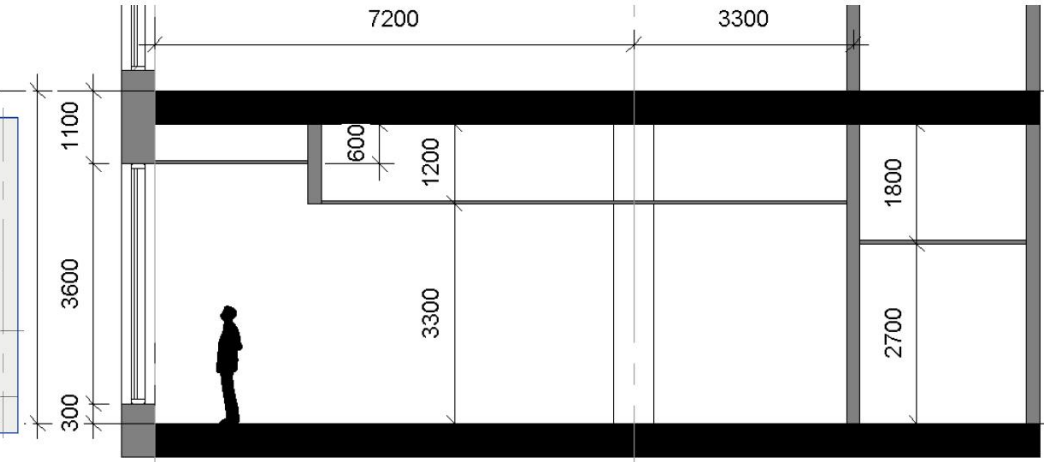
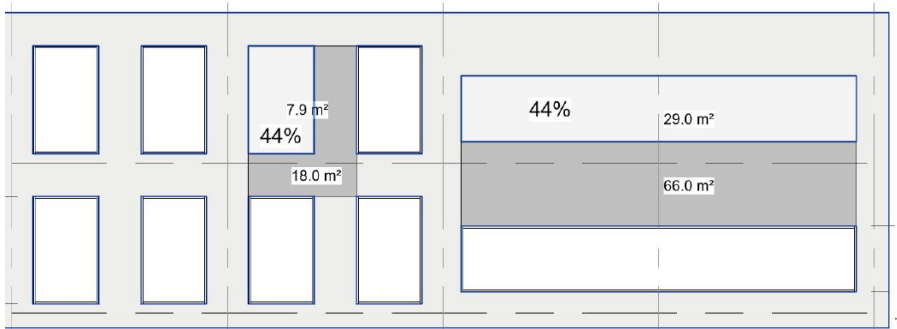

Tidligstudier proporsjoner - materialer

